

- LED Beacons p14-1
- Rotating Halogen Beacons p14-4
- Xenon Beacons p14-6
- Sirens p14-8

# 14



### C12



C12

- High output Amber beacon
- Permanent or magnetic mounting
- 10-30VDC
- 22 selectable flash patterns including five simulated rotating patterns
- Flash patterns externally selectable.
- Meets ECE R65 and SAE J845 Class 1

Order Code	Model	Mounting	Weight (kg)
79SS080402A	C12	3 point fixed	0.540
79SS080405A	C12	magnetic	1.460



C12M

#### Specifications:

**Voltage:** 10-30VDC  
**Light Source:** 12 x 3W LED  
**Max Power:** 19W  
**Flash rate:** 22 flash patterns  
**Protection:** IP67  
**Temp rating (°C):** -20 to +65  
**LED Life:** > 100,000 hours  
**Max. Vehicle Speed:** 140km/h (magnetic mount versions)  
**Connection:** 50cm 4 core cable (permanent mount)  
 2.5m coiled cabled with lighter plug (plug includes on/off and flash selection switches)  
**Construction:** ABS base, polycarbonate lens

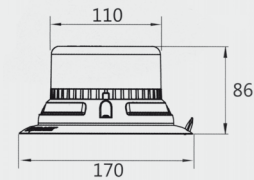
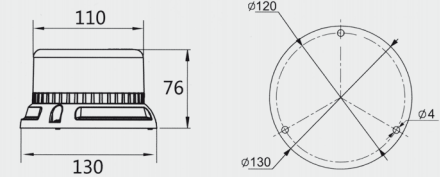

### C24



C24

- High output Amber beacon
- Permanent or magnetic mounting
- 10-30VDC
- 22 selectable flash patterns including five simulated rotating patterns
- Flash patterns externally selectable.
- Meets ECE R65 and SAE J845 Class 1

Order Code	Model	Mounting	Weight (kg)
79SS080102A	C24	3 point fixed	0.650
79SS080106A	C24	magnetic	1.530



C24M

#### Specifications:

**Voltage:** 10-30VDC  
**Light Source:** 24 x 3W LED  
**Max Power:** 37W  
**Flash rate:** 22 flash patterns  
**Protection:** IP67  
**Temp rating (°C):** -20 to +65  
**LED Life:** > 100,000 hours  
**Max. Vehicle Speed:** 140km/h (magnetic mount versions)  
**Connection:** 50cm 4 core cable (permanent mount)  
 2.5m coiled cabled with lighter plug (plug includes on/off and flash selection switches)  
**Construction:** ABS base, polycarbonate lens

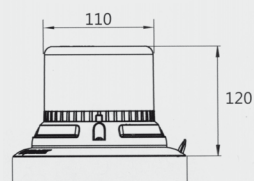
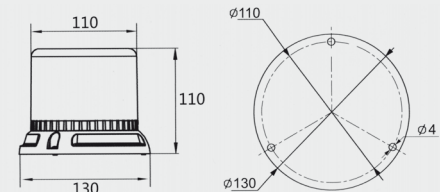

### ROTOVIS LED



- Rotating LED Amber beacon
- Permanent or magnetic mounting
- 12VDC
- Low current consumption and long lamp life
- Meets ECE R65 Class 1



Order Code	Model	Mounting	Weight (kg)
78ROTOVISLEDA	RotoVis LED	3 point fixed	0.70
78ROTOVISLEDAM	RotoVis LED	magnetic	1.04

#### Specifications:

**Voltage:** 12VDC  
**Light Source:** 3 x 5W LED  
**Current:** 0.7A  
**Flash rate:** 125 rpm  
**Protection:** IP65 (3 point mounting versions must be mounted on a flat surface)  
**Temp rating (°C):** -20 to +50  
**LED Life:** > 100,000 hours  
**Max. Vehicle Speed:** 110km/h (magnetic mount versions)  
**Connection:** Fast connectors (permanent mount) 2m coiled cabled with lighter plug (magnetic version)  
**Construction:** ABS base, polycarbonate lens



\*259 mm DIN POLE  
158 mm MAGNETIC

### Accessories and Spare Parts

Order Code	Description
781BOLT	Single Bolt Mounting Kit

### LB130



- High output LED beacon
- Permanent mounting (magnet and DIN mounting available on request)
- 10-30VDC
- 9 selectable flash patterns including simulated rotating pattern
- Flash patterns externally selectable.
- Meets ECE R65 and SAE J845 Class 1



Order Code	Model	Mounting	Weight (kg)
KSELB130*	LB130	3 point fixed	0.820

\*Specify colour A = Amber, B = Blue, G = Green, R = Red  
 Note: Green colour is supplied with clear lens and green LED's

#### Specifications:

**Voltage:** 10-30VDC  
**Light Source:** 12 x 3W LED  
**Max Power:** 27W  
**Flash rate:** 9 flash patterns  
**Protection:** IP67  
**Temp rating (°C):** -30 to +65  
**LED Life:** > 100,000 hours  
**Connection:** 30cm 3 core cable  
**Construction:** Aluminium alloy base, polycarbonate lens

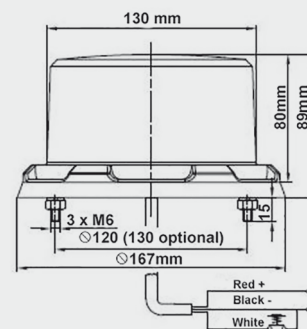

Select flash pattern by momentary connection of white wire to black wire

### Mini Adventurer

- High output Amber mini light bar
- Magnetic mounting
- 10-30VDC
- 25 selectable flash patterns including simulated rotating patterns
- Flash patterns externally selectable.
- Meets ECE R65 and SAE J845 Class 1



Order Code	Model	Mounting	Weight (kg)
79SS013101A	Mini Adventurer	magnetic	3.65

#### Specifications:

**Voltage:** 10-30VDC  
**Light Source:** 30 x 3W LED  
**Max Power:** 65W  
**Flash rate:** 25 flash patterns  
**Protection:** IP66  
**Temp rating (°C):** -20 to +65  
**LED Life:** > 100,000 hours  
**Max. Vehicle Speed:** 140km/h  
 (magnetic mount versions)  
**Connection:** 2.5m coiled cabled with lighter plug (plug includes on/off and flash selection switches)  
**Construction:** ABS and polycarbonate

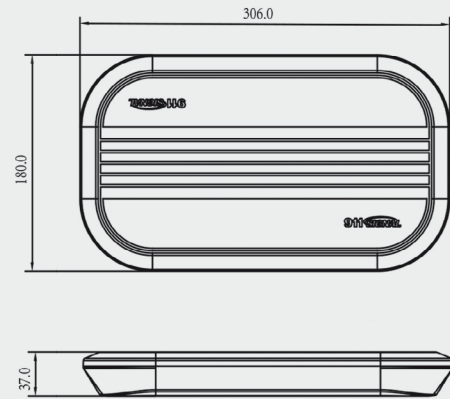

Dimensions in mm

# VEHICLE SIGNALLING

## Halogen Rotating Beacons



### ROTOVIS



- Rotating Amber beacon
- Permanent or magnetic mounting
- 12VDC
- Low cost for general applications

Order Code	Model	Mounting	Weight (kg)
78ROTOVISH12A	RotoVis H1	3 point fixed	0.400
78ROTOVISH12AM	RotoVis H1	magnetic	0.990

#### Specifications:

**Voltage:** 12VDC  
**Light Source:** H1 55W halogen  
**Current:** 4.6A  
**Flash rate:** 125 rpm  
**Protection:** IP65 (3 point mounting versions must be mounted on a flat surface)  
**Temp rating (°C):** -20 to +50  
**Max. Vehicle Speed:** 110km/h (magnetic mount versions)  
**Connection:** Fast connectors (permanent mount) 2m coiled cabled with lighter plug (magnetic version)  
**Construction:** ABS base, polycarbonate lens



\*259 mm DIN POLE  
158 mm MAGNETIC

### Accessories and Spare Parts

Order Code	Description
781BOLT	Single Bolt Mounting Kit
SIR3955012	55W 12V H1 bulb

### ROTCAR BV



- 3 point mounting or optional magnetic mounting
- Vibration absorbing rubber base
- Halogen lamps
- Dual Voltage 12/24V
- Application- Municipal vehicles, off-road vehicles, and bush fire trucks

Order Code	Mounting	Bulb
SIR7101200*	3 point fixed	55W 12V H1 70W 24V H1

\*Specify colour A = Amber, B = Blue, G = Green, R = Red (Lamp voltage must be specified)

#### Specifications:

**Voltage:** 12/24VDC (bulb voltage must be specified)  
**Flash rate:** 160 rpm  
**Protection:** IP66  
**Temp rating (°C):** -30 to +50  
**Cable entry:** Through base  
**Construction:** Rubber base, acrylic lens  
**Weight:** 0.8Kg

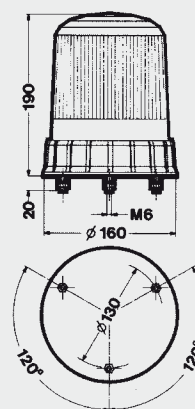

Dimensions in mm

### Accessories and Spare Parts

Order Code	Description
SIR9720001	B3M magnetic base and 3m cable
SIR3955012	55W 12V H1 bulb
SIR3970024	70W 24V H1 bulb
SIR3710001*	ROTCAR lens (*specify colour)

### BOULE BV



- ISO DIN plug in mounting
- Vibration absorbing flexible rubber base
- Tough spherical polycarbonate lens
- Halogen lamps
- Dual Voltage 12/24V
- Application – Municipal vehicles, mining, agricultural and earth moving machinery

Order Code	Mounting	Bulb
SIR7301201*	ISO DIN mounting	55W 12V H1 70W 24V H1

\*Specify colour A = Amber, B = Blue, R = Red

#### Specifications:

**Voltage:** 12/24VDC  
 (bulb voltage must be specified)  
**Flash rate:** 160 rpm  
**Protection:** IP66  
**Temp rating (°C):** -30 to +50  
**Cable entry:** Through Base  
**Construction:** Rubber base,  
 polycarbonate lens  
**Weight:** 0.84Kg

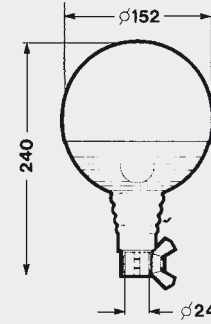

Dimensions in mm

### MICROROT FLX/2M



- ISO DIN plug in mounting or magnetic base
- Vibration absorbing flexible rubber base (DIN mount version)
- Tough polycarbonate lens
- Halogen lamps
- Application – mining, agricultural and earth moving machinery

Order Code	Mounting	Voltage	Bulb	Weight (kg)
SIR7201211*	ISO DIN	12VDC	55W 12V H1	0.7
SIR7202411*		24VDC	70W 24V H1	
SIR7201203*	magnetic	12VDC	55W 12V H1	1.0
SIR7202403*		24VDC	70W 24V H1	

\*Specify colour A = Amber, B = Blue, G = Green, R = Red

#### Specifications:

**Flash rate:** 160 rpm  
**Protection:** IP66  
**Temp rating (°C):** -30 to +50  
**Cable entry:** Through Base  
**Construction:** Rubber or nylon base,  
 polycarbonate Lens

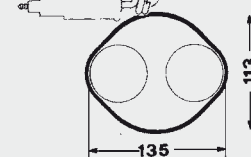
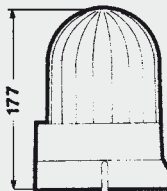
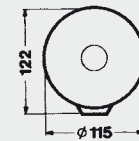
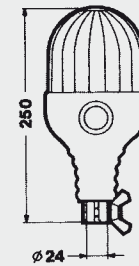

Dimensions in mm

### Accessories and Spare Parts

Order Code	Description
SIR9700001	B surface mount bracket
SIR9700006	SP side mount bracket
SIR9700009	SPRT adjustable extension pole
SIR3955012	55W 12V H1 bulb
SIR3970024	70W 24V H1 bulb
SIR3730001*	BOULE lens (*Specify colour)
SIR3720001*	MICROROT lens (*Specify colour)

### RB Series



- 3 point or magnetic mounting
- Dual voltage 12/24V versions
- Multi-voltage versions for battery powered vehicles
- High efficiency
- Application – commercial vehicles, service vehicles, materials handling, and cleaning machines

#### Specifications:

Protection: IP65  
 Temp rating (°C): -20 to +55  
 Cable entry: Through base  
 Construction: ABS base, polycarbonate lens  
 Weight: 0.4Kg  
 (0.82kg magnetic base version)

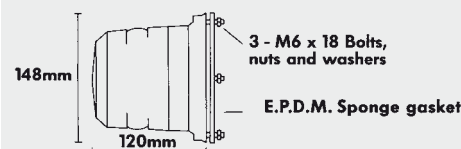
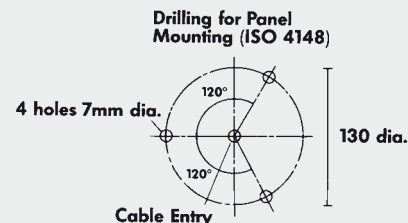

Order Code	Model	Voltage	Current	Flash Energy	Light Output	Flash Rate
DLR401206*	RB4XDV/6	10-32VDC	300-600mA	4J	>50Cd (e)	75fpm
DLR401206*MAG	RB4XDV/6MAG	10-32VDC	300-600mA			
DLR201215*	RB2XDV/15	10-33VDC	0.75-1.5A	6.0 J	>60Cd (e)	125fpm
DLR401002*	RB4XMV/2P#	10-100VDC 30-60VAC	145-40mA	1.5 J	>18Cd (e)	75fpm
DLR401005*	RB4XMV/5	10-100VDC 30-60VAC	360-60mA	4.0 J	>44Cd (e)	75fpm

\*Specify colour A = Amber, B = Blue, G = Green, R = Red

# Available in Amber only

### EL Series



- 3 point or magnetic mounting
- Dual voltage 12/24V versions
- High efficiency
- Double flash
- Application – commercial vehicles, service vehicles, and emergency vehicles

Order Code	Mounting	Weight (kg)
DLE201215A	3 point fixed	0.6

\*Specify colour A = Amber, B = Blue, G = Greens, R = Red

#### Specifications:

Voltage: 10-33VDC  
 Current: 1.5-0.75A  
 Flash rate: 120 fpm  
 Light output: >100Cd (e)  
 Protection: IP65  
 Temp rating (°C): -20 to +55  
 Cable entry: Through base  
 Construction: ABS base, Polycarbonate lens

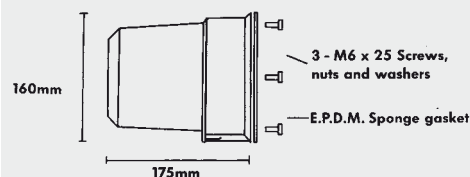

### Accessories and Spare Parts



FX9



FX10



FX12



FX13



FX60

Order Code	Description
DLFX9	FX9 steel guard for RB series
DLFX10	FX10 steel guard for EL series
DLFX60	FX60 magnetic kit RB Series
DLFX11	FX11 magnetic kit EL Series
DLFX7	FX7 single bolt mount RB series
DLFX12	FX12 single bolt mount EL series
DLFX13	FX13 Pole Mount Kit RB - EL Series
DL900050	RB2XDV/15 xenon tube kit
DL900051	RB4XMV/5 xenon tube kit
DL900060	ELB2DXDV/15 Xenon tube kit
DL900030*	RB lens (*Specify colour)
DL900040*	EL lens (*Specify colour)



### Super Celere

*SIRENA*



- Motor siren with 114dB output
- 12 or 24Vdc
- Continuously rated
- Ideal blast warning siren

Order Code	Voltage	Current
SIR4501210	12VDC	9.5A
SIR4502410	24VDC	5.0A

#### Specifications:

**Sound output:** 114dB @ 1m  
**Frequency:** 820Hz  
**Protection:** IP44  
**Rating:** Continuous  
**Temp rating (°C):** -30 to +50  
**Cable entry:** M12  
**Construction:** polycarbonate  
**Weight:** 1.5Kg

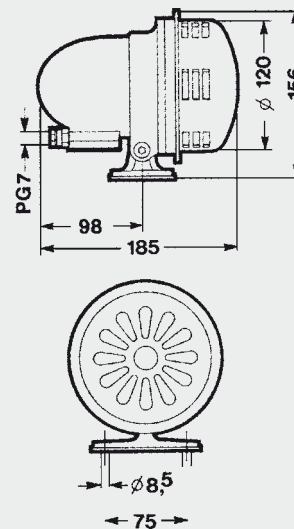

Dimensions in mm

### Banshee Mono S



- Sound output up to 123dB @ 1m
- Robust die cast aluminium housing
- Continuous rating
- IP65

Order Code	Voltage	Current
KAMMS012	12VDC	15A
KAMMS024	24VDC	10.6A

#### Specifications:

**Sound output:** 120dB @ 1m  
**Sound frequency:** 905 Hz  
**Protection:** IP65  
**Rating:** Continuous (with thermal protector)  
**Voltage tolerance:** ±10%  
**Temperature range (°C):** -30 to +45  
**Cable Entry:** 2 x M20  
**Construction:** Powder coated aluminium  
**Weight:** 1.66Kg

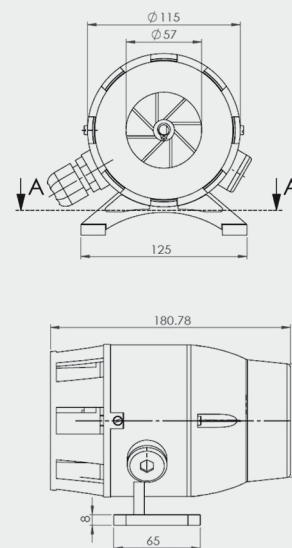

Dimensions in mm

### MAP1008D PA Siren

- Up to 126dB output
- 5 tones + PA
- Volume control
- Hand held controller with built in microphone



Order Code	Description	Weight (kg)
MXMAP1008D12	Siren amplifier with hand held control	1.2
MXMA10002MH02	100W horn speaker	1.5

#### Specifications:

Voltage:	10-16VDC
Operating current:	9A max
Standby current:	1A
Output:	100W max
Rated load impedance:	11Ω
Tones:	Wail Yelp Hi-Lo Air Horn Dual
Frequency:	700-1500Hz
Speaker Dimensions:	135H x 190W x 200D mm

