

LOVATO ELECTRIC S.P.A.

24020 GORLE (BERGAMO) ITALIA
VIA DON E. MAZZA, 12
TEL. 035 4282111
FAX (Nazionale): 035 4282200
FAX (International): +39 035 4282400
E-mail info@LovatoElectric.com
Web www.LovatoElectric.com

GB 2G/3G MODEM
Instructions manual
I MODEM 2G/3G
Manuale operativo
EXC M3G 01

WARNING!

- Carefully read the manual before the installation or use.
- This equipment is to be installed by qualified personnel, complying to current standards, to avoid damages or safety hazards.
- Before any maintenance operation on the device, remove all the voltages from measuring and supply inputs and short-circuit the CT input terminals.
- The manufacturer cannot be held responsible for electrical safety in case of improper use of the equipment.
- Products illustrated herein are subject to alteration and changes without prior notice. Technical data and descriptions in the documentation are accurate, to the best of our knowledge, but no liabilities for errors, omissions or contingencies arising there from are accepted.
- A circuit breaker must be included in the electrical installation of the building. It must be installed close by the equipment and within easy reach of the operator. It must be marked as the disconnecting device of the equipment: IEC / EN 61010-1 § 6.11.2.
- Clean the device with a soft dry cloth; do not use abrasives, liquid detergents or solvents.

ATTENTION !

- Lire attentivement le manuel avant toute utilisation et installation.
- Ces appareils doivent être installés par un personnel qualifié, conformément aux normes en vigueur en matière d'installations, afin d'éviter de causer des dommages à des personnes ou choses.
- Avant toute intervention sur l'instrument, mettre les entrées de mesure et d'alimentation hors tension et court-circuiter les transformateurs de courant.
- Le constructeur n'assume aucune responsabilité quant à la sécurité électrique en cas d'utilisation impropre du dispositif.
- Les produits décrits dans ce document sont susceptibles d'évoluer ou de subir des modifications à n'importe quel moment. Les descriptions et caractéristiques techniques du catalogue ne peuvent donc avoir aucune valeur contractuelle.
- Un interrupteur ou disjoncteur doit être inclus dans l'installation électrique du bâtiment. Celui-ci doit se trouver tout près de l'appareil et l'opérateur doit pouvoir y accéder facilement. Il doit être marqué comme le dispositif d'interruption de l'appareil : IEC / EN 61010-1 § 6.11.2.
- Nettoyer l'appareil avec un chiffon doux, ne pas utiliser de produits abrasifs, détergents liquides ou solvants.

ACHTUNG!

- Dieses Handbuch vor Gebrauch und Installation aufmerksam lesen.
- Zur Vermeidung von Personen- und Sachschäden dürfen diese Geräte nur von qualifiziertem Fachpersonal und unter Befolgung der einschlägigen Vorschriften installiert werden.
- Vor jedem Eingriff am Instrument die Spannungszufuhr zu den Messeingängen trennen und die Stromwandler kurzschließen.
- Bei zweckwidrigem Gebrauch der Vorrichtung übernimmt der Hersteller keine Haftung für die elektrische Sicherheit.
- Die in dieser Broschüre beschriebenen Produkte können jederzeit weiterentwickelt und geändert werden. Die im Katalog enthaltenen Beschreibungen und Daten sind daher unverbindlich und ohne Gewähr.
- In die elektrische Anlage des Gebäudes ist ein Ausschalter oder Trennschalter einzubauen. Dieser muss sich in unmittelbarer Nähe des Geräts befinden und vom Bediener leicht zugänglich sein. Er muss als Trennvorrichtung für das Gerät gekennzeichnet sein: IEC / EN 61010-1 § 6.11.2.
- Das Gerät mit einem weichen Tuch reinigen, keine Scheuermittel, Flüssigreinerer oder Lösungsmittel verwenden.

ADVERTENCIA

- Leer atentamente el manual antes de instalar y utilizar el regulador.
- Este dispositivo debe ser instalado por personal cualificado conforme a la normativa de instalación vigente a fin de evitar daños personales o materiales.
- Antes de realizar cualquier operación en el dispositivo, desconectar la corriente de las entradas de alimentación y medida, y cortocircuitar los transformadores de corriente.
- El fabricante no se responsabilizará de la seguridad eléctrica en caso de que el dispositivo no se utilice de forma adecuada.
- Los productos descritos en este documento se pueden actualizar o modificar en cualquier momento. Por consiguiente, las descripciones y los datos técnicos aquí contenidos no tienen valor contractual.
- La instalación eléctrica del edificio debe disponer de un interruptor o disyuntor. Este debe encontrarse cerca del dispositivo, en un lugar al que el usuario pueda acceder con facilidad. Además, debe llevar el mismo marcado que el interruptor del dispositivo (IEC / EN 61010-1 § 6.11.2).
- Limpiar el dispositivo con un trapo suave; no utilizar productos abrasivos, detergentes líquidos ni disolventes.

UPOZORNĚNÍ

- Návod se pozorně pročtěte, než začnete regulátor instalovat a používat.
- Tato zařízení smí instalovat kvalifikovaní pracovníci v souladu s platnými předpisy a normami pro předcházení úrazu osob či poškození věcí.
- Před jakýmkoli zásahem do přístroje odpojte měřicí a napájecí vstupy od napětí a zkratujte transformátory proudů.
- Výrobce nenese odpovědnost za elektrickou bezpečnost v případě nevhodného používání regulátoru.
- Výrobky popsané v tomto dokumentu mohou kdykoli projít úpravami či dalším vývojem. Popisy a údaje uvedené v katalogu nemají proto žádnou smluvní hodnotu.
- Spínač či odpojovač je nutno zabudovat do elektrického rozvodu v budově. Musejí být nainstalované v těsné blízkosti přístroje a snadno dostupné pracovníku obsluhy. Je nutno ho označit jako vypínači zařízení přístroje: IEC / EN 61010-1 § 6.11.2.
- Přístroj čistěte měkkou utěrkou, nepoužívejte abrazivní produkty, tekutá čistidla či rozpouštědla.

AVERTIZARE!

- Citiți cu atenție manualul înainte de instalare sau utilizare.
- Acest echipament va fi instalat de personal calificat, în conformitate cu standardele actuale, pentru a evita deteriorări sau pericolose.
- Înainte de efectuarea oricărei operațiuni de întreținere asupra dispozitivului, îndepartați toate tensiunile de la intrările de măsurare și de alimentare și scurtcircuitați bornele de intrare CT.
- Producătorul nu poate fi considerat responsabil pentru siguranța electrică în caz de utilizare incorectă a echipamentului.
- Produsele ilustrate în prezentul sunt supuse modificărilor și schimbărilor fără notificare anterioară. Datele tehnice și descrierile din documentație sunt precise, în măsura cunoștințelor noastre, dar nu se acceptă nicio răspundere pentru erorile, omisiunile sau evenimentele neprevăzute care apar ca urmare a acestora.
- Trebuie inclus un disjuncteur în instalația electrică a clădirii. Acesta trebuie instalat aproape de echipament și într-o zonă ușor accesibilă operatorului. Acesta trebuie marcat ca fiind dispozitivul de deconectare al echipamentului: IEC/EN 61010-1 § 6.11.2.
- Curățați instrumentul cu un material textil moale și uscat; nu utilizați substanțe abrazive, detergenți lichizi sau solvenți.

ATTENZIONE!

- Leggere attentamente il manuale prima dell'utilizzo e l'installazione.
- Questi apparecchi devono essere installati da personale qualificato, nel rispetto delle vigenti normative impiantistiche, allo scopo di evitare danni a persone o cose.
- Prima di qualsiasi intervento sullo strumento, togliere tensione dagli ingressi di misura e di alimentazione e cortocircuare i trasformatori di corrente.
- Il costruttore non si assume responsabilità in merito alla sicurezza elettrica in caso di utilizzo improprio del dispositivo.
- I prodotti descritti in questo documento sono suscettibili in qualsiasi momento di evoluzioni o di modifiche. Le descrizioni ed i dati a catalogo non possono pertanto avere alcun valore contrattuale.
- Un interruttore o disgiuntore va compreso nell'impianto elettrico dell'edificio. Esso deve trovarsi in stretta vicinanza dell'apparecchio ed essere facilmente raggiungibile da parte dell'operatore. Deve essere marchiato come il dispositivo di interruzione dell'apparecchio: IEC / EN 61010-1 § 6.11.2.
- Pulire l'apparecchio con panno morbido, non usare prodotti abrasivi, detergenti liquidi o solventi.

UWAGA!

- Przed użyciem i instalacją urządzenia należy uważnie przeczytać niniejszą instrukcję.
- W celu uniknięcia obrażeń osób lub uszkodzenia mienia tego typu urządzenia muszą być instalowane przez wykwalifikowany personel, zgodnie z obowiązującymi przepisami.
- Przed rozpoczęciem jakichkolwiek prac na urządzeniu należy odłączyć napięcie od wejść pomiarowych i zasilania oraz zewrzeć zaciski przekładnika prądowego.
- Producent nie przyjmuje na siebie odpowiedzialności za bezpieczeństwo elektryczne w przypadku niewłaściwego użytkowania urządzenia.
- Produkty opisane w niniejszym dokumencie mogą być w każdej chwili udoskonalone lub zmodyfikowane. Opisy oraz dane katalogowe nie mogą mieć w związku z tym żadnej wartości umownej.
- W instalacji elektrycznej budynku należy uwzględnić przełącznik lub wyłącznik automatyczny. Powinien on znajdować się w bliskim sąsiedztwie urządzenia i być łatwo osiągalny przez operatora. Musi być oznaczony jako urządzenie służące do wyłączania urządzenia: IEC / EN 61010-1 § 6.11.2.
- Urządzenie należy czyścić miękką szmatką, nie stosować środków ściernych, płynnych detergentów lub rozpuszczalników.

警告!

- 安装或使用前，请仔细阅读本手册。
- 本设备只能由合格人员根据现行标准进行安装，以避免造成损坏或安全危害。
- 对设备进行任何维护操作前，请移除测量输入端和电源输入端的所有电压，并短接 CT 输入端。
- 制造商不负责因设备使用不当导致的电气安全问题。
- 此处说明的产品可能会有变更，恕不提前通知。我们竭力确保本文件中技术数据和说明的准确性，但对于错误、遗漏或由此产生的意外事件概不负责。
- 建筑电气系统中必须装有断路器。断路器必须安装在靠近设备且方便操作人员触及的地方。必须将断路器标记为设备的断开装置：IEC/EN 61010-1 § 6.11.2。
- 请使用柔软的干布清洁设备；切勿使用研磨剂、洗涤剂或溶剂。

ПРЕДУПРЕЖДЕНИЕ!

- Прежде чем приступать к монтажу или эксплуатации устройства, внимательно ознакомьтесь с содержанием настоящего руководства.
- Во избежание травм или материального ущерба монтаж должен осуществляться только квалифицированным персоналом в соответствии с действующими нормативами.
- Перед проведением любых работ по техническому обслуживанию устройства необходимо обеспечить все измерительные и питающие входные контакты, а также замкнуть коротко входные контакты трансформатора тока (ТТ).
- Производитель не несет ответственность за обеспечение электробезопасности в случае ненадлежащего использования устройства.
- Изделия, описанные в настоящем документе, в любой момент могут подвергнуться изменению или усовершенствованию. Поэтому каталожные данные и описания не могут рассматриваться как действительные с точки зрения контрактов.
- Электрическая сеть здания должна быть оснащена автоматическим выключателем, который должен быть расположен вблизи оборудования в пределах доступа оператора. Автоматический выключатель должен быть промаркирован как отключающее устройство оборудования: IEC / EN 61010-1 § 6.11.2.
- Очистку устройства производить с помощью мягкой сухой ткани, без применения абразивных материалов, жидких мощных средств или растворителей.

DIKKAT!

- Montaj ve kullanımdan önce bu el kitabını dikkatlice okuyunuz.
- Bu aparatlar kişilere veya nesnelere zarar verme ihtimaline karşı yürürlükte olan sistem kurma normlarına göre kalifiye personel tarafından monte edilmelidirler.
- Aparata (cihaz) herhangi bir müdahalede bulunmadan önce ölçüm girişlerindeki genilimi kesip akım transformatorlerinede kısa devre yaptırınız.
- Üretici aparatın hatalı kullanımından kaynaklanan elektriksel güvenliği ait sorumluluk kabul etmez.
- Bu dokümanda tarif edilen ürünler her an evrimlere veya değişimlere açıktır. Bu sebeple katalogdaki tarif ve değerler herhangi bir bağlayıcı değeri haiz değildir.
- Binanın elektrik sisteminde bir anahtar veya şalter bulunmalıdır. Bu anahtar veya şalter operatörün kolaylıkla ulaşabileceği yakın bir yerde olmalıdır. Aparatı (cihaz) devreden çıkartma görevi yapan bu anahtar veya şalterin markası: IEC / EN 61010-1 § 6.11.2.
- Aparatı (cihaz) sıvı deterjan veya solvent kullanılarak yumuşak bir bez ile siliniz aşındırıcı temizlik ürünleri kullanmayınız.



INDEX	Page
Introduction	2
Description	2
Frontal indication	2
Configuration software	3
Installation	4
Wiring diagrams	4
Mechanical dimensions and terminal arrangement	4
Technical characteristics	5

INTRODUCTION

EXC M3G 01 2G/3G modem is designed to let the slave devices connect via the RS485 serial port interface to a master through 2G or 3G phone network. The data can be collected without the need to add the devices into the network infrastructure or in all those cases where the network is not available.

DESCRIPTION

Contents

- 2G/3G modem (the network type can be automatically selected by the modem or forced by the user).
- Outside antenna, IP69K.
- USB programming cable (the software can be downloaded from www.lovatoelectric.com web site.)

Modem

- DIN rail mounting.
- 4 modules (72mm).
- Power supply: 9.5...35VDC / 9.5...27VAC.
- Power consumption: 250mW (10W peak).
- 1 built-in RS485 port (A, B, GND).
- Programmable RS485 port (baudrate from 300 to 115200bps).
- SIM card slot suitable for 3V or 1.8V cards.
- SIM PIN number management.
- Compliance with FCC rules, parts 15B-22H-27-24E.
- IP40 protection degree.
- Gateway between 2G/3G network and RS485 serial communication (transparent mode).
- Programmable APN server access.
- Configurable master remote IP address and port.
- Network status details.

Antenna

- Penta band antenna, 850/900/1800/1900/2100 MHz.
- Mounting: M10 through hole and adhesive gasket.

FRONTAL INDICATIONS

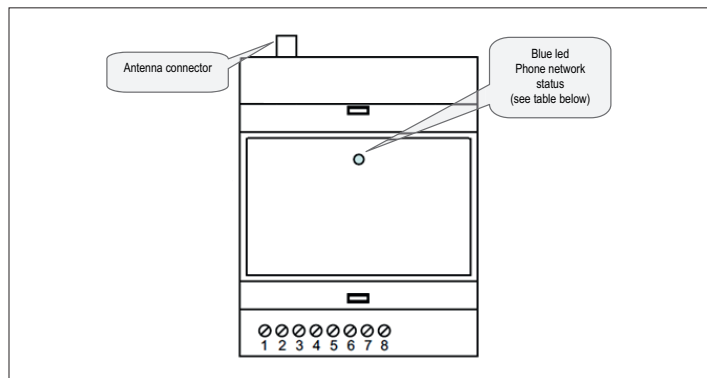

Network status blue led	Meaning
OFF	Modem not powered
Steady ON	Network registration failure (bad or missing PIN)
Flashing (1s On – 2s Off)	Network ready

INDICE	Pagina
Introduzione	2
Descrizione	2
Indicazioni sul fronte	2
Software di configurazione	3
Installazione	4
Schemi di collegamento	4
Dimensioni meccaniche e disposizione morsetti	4
Caratteristiche tecniche	5

INTRODUZIONE

Il modem 2G/3G EXC M3G 01 è stato pensato per interfacciare i dispositivi slave collegati tramite la porta seriale RS485 con un master attraverso la rete telefonica 2G o 3G. In questo modo è possibile raccogliere i dati senza la necessità di aggiungere i dispositivi all'interno dell'infrastruttura di rete o nei casi in cui quest'ultima è del tutto inesistente.

DESCRIZIONE

Contenuto

- Modem 2G/3G (il tipo di rete può essere scelto automaticamente dal modem o forzata dall'utente).
- Antenna per esterni IP69K.
- Cavo di programmazione USB (software scaricabile dal sito internet www.lovatoelectric.com).

Modem

- Montaggio su guida DIN.
- 4 moduli (72mm).
- Alimentazione 9.5...35VDC / 9.5...27VAC.
- Consumo 250mW (10W picco).
- 1 porta RS485 (A, B, GND).
- Porta seriale RS485 programmabile (baudrate da 300 a 115200bps).
- Alloggiamento per SIM card da 3V e 1.8V.
- Gestione del PIN della SIM.
- Certificato secondo FCC rules, parts 15B-22H-27-24E.
- Grado di protezione IP40.
- Gateway tra rete 2G/3G e comunicazione seriale RS485 (modalità trasparente).
- Accesso a server APN programmabile.
- IP e porta remota master impostabili.
- Rilievo della copertura cellulare.

Antenna

- Antenna penta band 850/900/1800/1900/2100 MHz.
- Montaggio: foro M10 passante e guarnizione adesiva.

INDICAZIONI SUL FRONTE

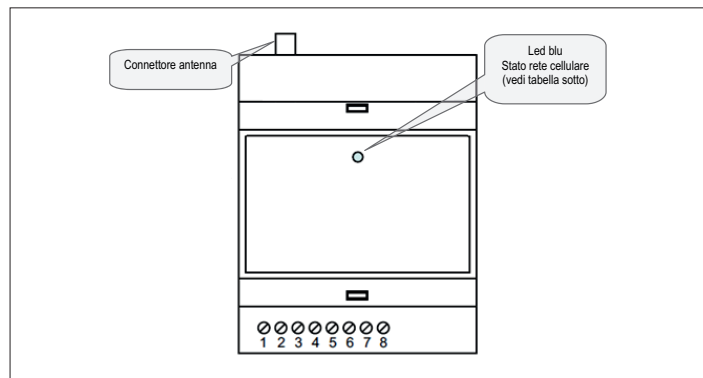

Stato led blu rete	Significato
OFF	Modem non alimentato
ON fisso	Mancata registrazione in rete (pin errato o mancante)
Lampeggio (1s On – 2s Off)	Registrazione in rete corretta

CONFIGURATION SOFTWARE

In order to set up EXC M3G 01 modem, EXCM3GSW software is required. It is downloadable from www.lovatoelectric.com web site.

The software can work either directly connected to the device through the USB cable included in the package or creating a configuration file.

The software has not to be installed. It is enough to unzip the archive file and run the executable file named EXCM3GSW.exe. A window opens giving the possibility to choose between the direct connection and the creation of the file to be loaded afterwards.

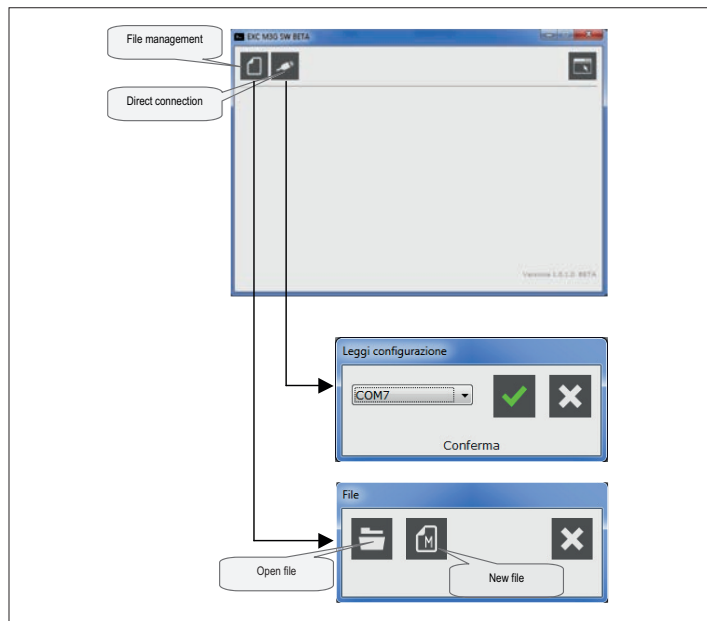

The direct connection is possible only if the SIM card is correctly inserted. Loading LovatoDefault.m3g file included in the same directory from where the software has been launched, the modem is automatically set to connect to LOVATO Electric Synergy Cloud web site.

MODEM CONFIGURATION

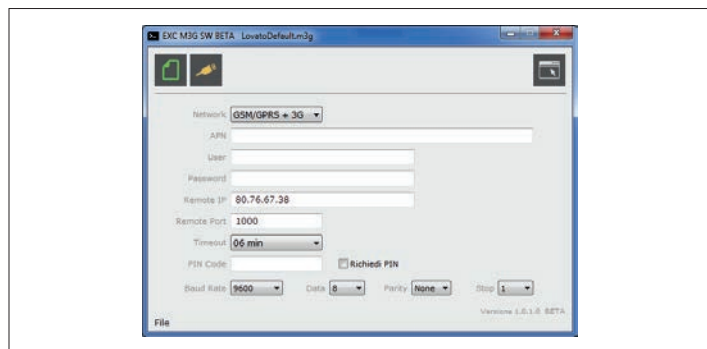





- **Network:** selection among 2G, 3G networks or both of them according to their availability with priority for 3G (suggested selection);
- **APN:** APN server IP address (ask SIM supplier);
- **User:** user name for APN server (ask SIM supplier);
- **Password:** key for APN server (ask SIM supplier);
- **Remote IP:** remote server IP address;
- **Remote Port:** remote server access port;
- **Timeout:** time elapsed without data exchange before the modem disconnects and connects again;
- **PIN code:** insert SIM card PIN number if required;
- **PIN enable:** flag to enable the PIN control operated by the modem;
- **Baudrate, Data, Parity, Stop:** serial parameters for RS485 port.

If the "file" mode is active, click on  icon to send the configuration file to the device or quit the software to save the file.

 **Terminal**

Clicking on  an ASCII terminal is open to directly communicate with the modem through AT commands.

Some icons are available to quickly send commands to:

-  set the modem clock;
-  download the diagnostic information;
-  download the latest events;
-  change the PIN number of the SIM card;
-  device reboot.

SOFTWARE DI CONFIGURAZIONE

Per configurare il modem EXC M3G 01 è necessario utilizzare il software EXCM3GSW scaricabile dal sito internet www.lovatoelectric.com.

Il software può lavorare collegato allo strumento tramite il cavo USB incluso nella confezione oppure offline creando un file di configurazione.

Non è necessario installare il software. E' sufficiente scompattare il file di archivio e lanciare l'eseguibile EXCM3GSW.exe. Si apre la finestra che permette di scegliere se lavorare direttamente connessi con il dispositivo oppure se operare su un file da caricare successivamente.

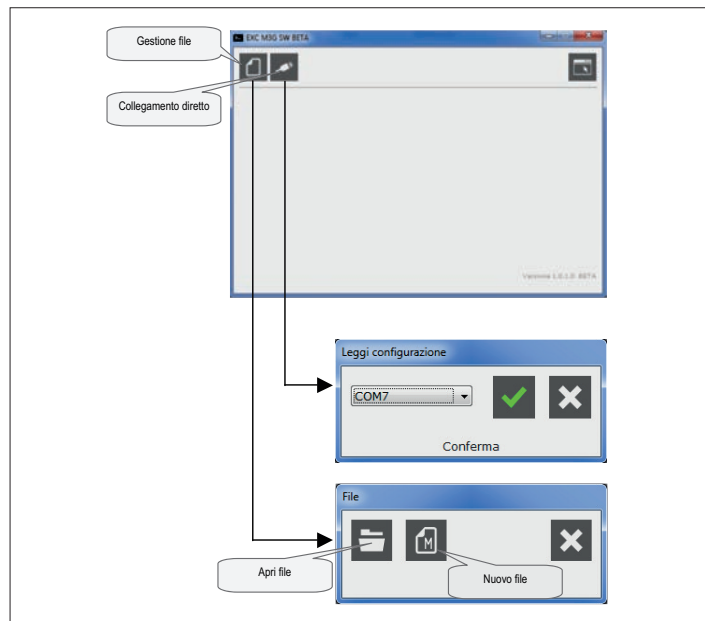

Il collegamento diretto è possibile solo con SIM inserita correttamente. Caricando il file LovatoDefault.m3g che si trova nella stessa cartella da cui è stato lanciato il programma, il modem viene già preimpostato per collegarsi al sito Synergy Cloud di LOVATO Electric.

CONFIGURAZIONE DEL MODEM

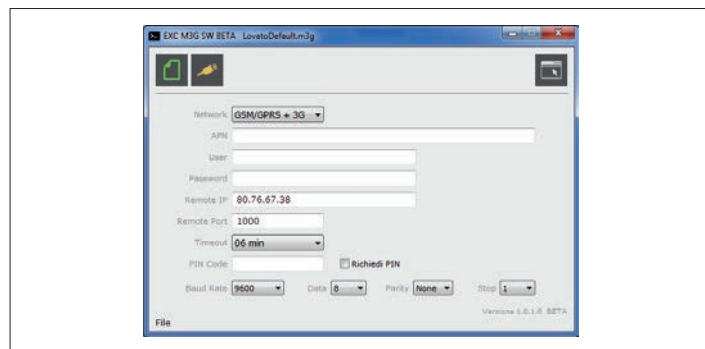





- **Network:** scelta tra rete 2G, 3G o entrambe in base alla disponibilità, con precedenza 3G (scelta consigliata);
- **APN:** indirizzo IP del server APN (chiedere al fornitore della SIM);
- **User:** nome utente per il server APN (chiedere al fornitore della SIM);
- **Password:** chiave di accesso per il server APN (chiedere al fornitore della SIM);
- **Remote IP:** indirizzo IP del server remoto;
- **Remote Port:** porta di accesso al server remoto;
- **Timeout:** tempo atteso dal modem senza scambio dati prima di abbattere la connessione e riconnettersi;
- **PIN code:** inserire il PIN della SIM se richiesto;
- **PIN enable:** flag per abilitare il controllo del PIN da parte del modem;
- **Baudrate, Data, Parity, Stop:** parametri seriali per la porta RS485.

Se si è in modalità "file", cliccare sull'icona  per inviare il file al dispositivo o chiudere il software per salvare il file.

 **Terminale**

Cliccando su  viene aperto un terminale ASCII con cui dialogare direttamente con il modem tramite comandi AT.

Sono disponibili icone che permettono di inviare velocemente i comandi per:

-  impostare l'orologio del modem;
-  leggere la diagnostica;
-  scaricare gli ultimi eventi;
-  modificare il PIN della SIM;
-  riavviare il dispositivo.

EXC M3G 01 and PC connection through included USB cable

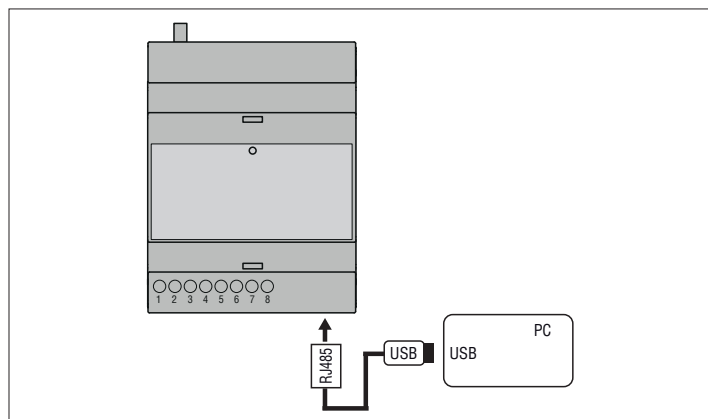

Collegamento EXC M3G 01 con PC tramite cavo USB incluso

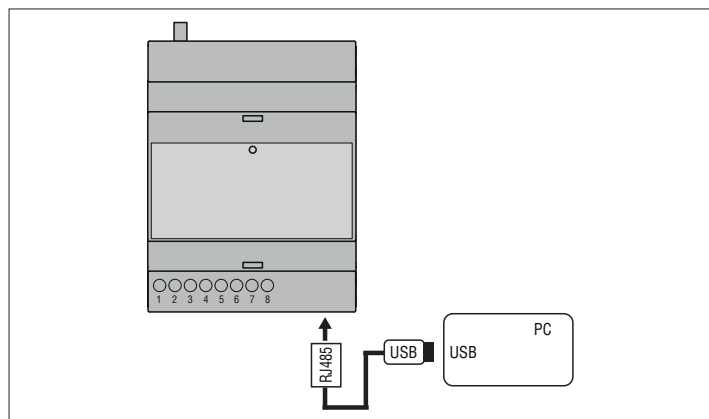

INSTALLATION

Modem

- EXC M3G 01 can be mounted on DIN rail (EN-50022).
- The installation must ensure IP40 protection degree minimum.
- For electrical connection, refer to the wiring diagram and to specification in the electrical characteristics, described in the dedicated sections.

SIM card

- Unplug the power or switch off the modem using the software before inserting or removing the SIM card.
- Use 3V or 1.8V SIM card only.
- Put the cover in position again before operating the device.

INSTALLAZIONE

Modem

- EXC M3G 01 è adatto al montaggio su guida DIN EN-50022 o in centralini modulari.
- L'installazione deve garantire un grado di protezione minimo IP40.
- Per i collegamenti elettrici fare riferimento agli schemi di connessione riportati nell'apposito capitolo e alle prescrizioni riportate nella tabella delle caratteristiche tecniche.

SIM card

- Scollegare l'alimentazione o spegnere il modem con il software prima di inserire o rimuovere la carta SIM.
- Inserire SIM card da 3V o 1.8V
- Riposizionare il coperchio prima di alimentare nuovamente il dispositivo.

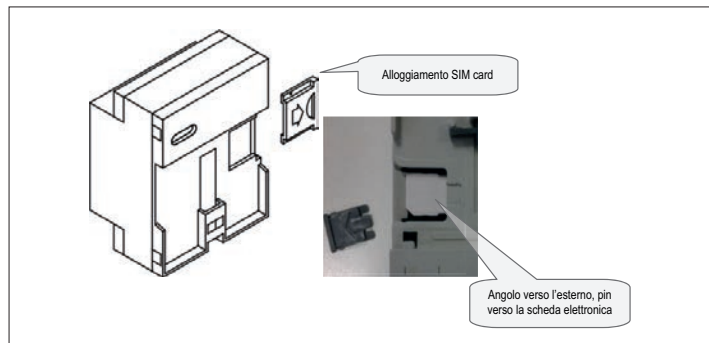
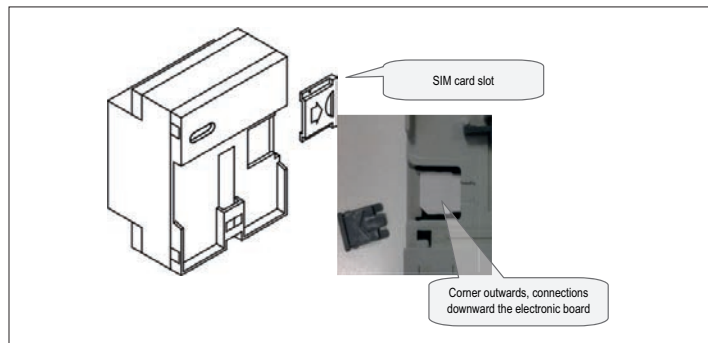

Wiring diagrams

Schemi di collegamento

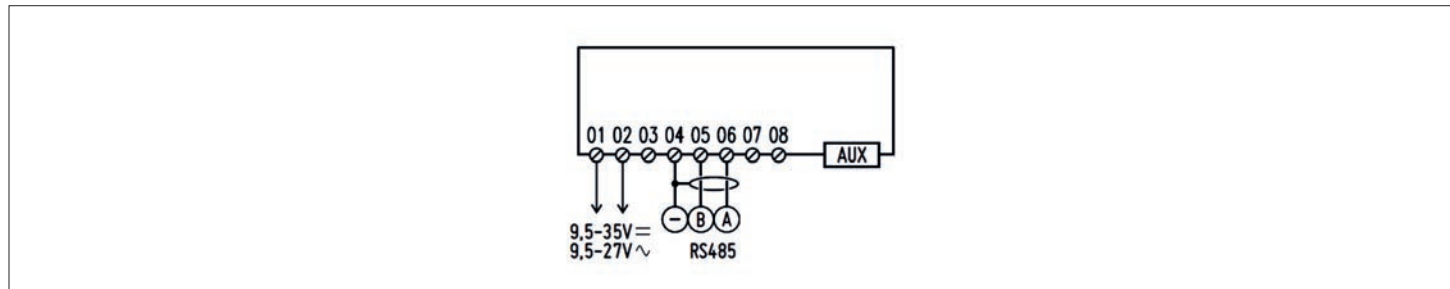

Terminal arrangement and mechanical dimensions [mm]

Disposizione morsetti e dimensioni meccaniche [mm]

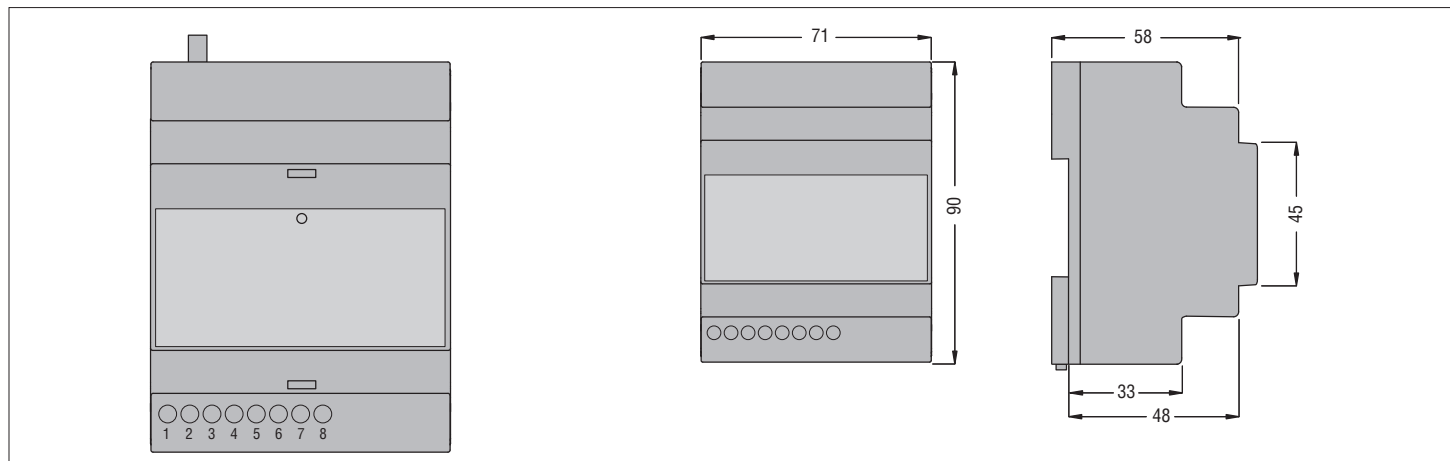



TECHNICAL CHARACTERISTICS

Power supply (terminals 1-2)

Rated voltage Us	12 - 24V~ 12 - 24=
------------------	-----------------------

Operating voltage range	9.5 - 27V~ 9.5 - 35V=
-------------------------	--------------------------

Frequency	50/60Hz
Power consumption/dissipation	250mW (idle) 10W (peak)

Ambient conditions

Operating temperature	-40 – 85°C
Relative humidity	<85%

Connections

Type of terminal	Plug-in / removable
Conductor cross section (min... max)	0.2...2.5 mm ² (24 - 12 AWG)

RS485 serial port (terminals 4-5-6)

Baud rate	300, 600, 1200, 2400, 4800, 9600, 19200, 38400, 57600, 115200 bps
-----------	--

Data	7-8 bit
Parity	None, odd, even
Stop bit	1-2

Modem GSM

Frequency band	Penta band GSM 850/900/1800/1900/2100MHz
Output power	Class 4 (2W, 33dBm) per GSM 850/900 Class 1 (1W, 30dBm) per GSM 1800/1900 Class 3 (0.25W, 24dBm) per UMTS Class E2 (0.5W, 27dBm) per EDGE 850/900 Class E2 (0.4W, 26dBm) per EDGE 1800/1900

Antenna

Type	Surface mounting, outside installation, IP69K
------	---

Frequency	AMPS 850MHz GSM 900MHz DCS 1800MHz PCS 1900MHz UMTS 2100MHz
-----------	---

Impedance	50ohm
-----------	-------

Operating temperature	-40 – +85°C
-----------------------	-------------

Gain	0dBi
------	------

Dimensions	Ø50 x 16mm
------------	------------

Cable	2.5m
-------	------

Connector	SMA
-----------	-----

Mounting	M10 through hole + adhesive gasket
----------	------------------------------------

Housing

Version	DIN rail EN-50022
---------	-------------------

Dimensions	4 modules (72mm)
------------	------------------

Material	Polycarbonate
----------	---------------

Degree of protection	IP40 on front – IP20 terminals
----------------------	--------------------------------

Weight	200g
--------	------

Certifications and compliance

Reference standards	EN 60950-1:2006 FCC rules, parts 15B-22H-27-24E
---------------------	--



CARATTERISTICHE TECNICHE

Alimentazione (morsetti 1-2)

Tensione nominale Us	12 - 24V~ 12 - 24=
----------------------	-----------------------

Limiti di funzionamento	9,5 - 27V~ 9,5 - 35V=
-------------------------	--------------------------

Frequenza	50/60Hz
-----------	---------

Potenza assorbita/dissipata	250mW (a riposo) 10W (picco)
-----------------------------	---------------------------------

Condizioni ambientali

Temperatura d'impiego	-40 – 85°C
Umidità relativa	<85%

Conessioni

Tipo di morsetti	Fissi
Sezione conduttori (min e max)	0.2...2.5 mm ² (24 - 12 AWG)

Porta seriale RS485 (morsetti 4-5-6)

Baud rate	300, 600, 1200, 2400, 4800, 9600, 19200, 38400, 57600, 115200 bps
-----------	--

Data	7-8 bit
Parity	None, odd, even
Stop bit	1-2

Modem GSM

Bande di frequenza	Penta band GSM 850/900/1800/1900/2100MHz
Output power	Class 4 (2W, 33dBm) per GSM 850/900 Class 1 (1W, 30dBm) per GSM 1800/1900 Class 3 (0.25W, 24dBm) per UMTS Class E2 (0.5W, 27dBm) per EDGE 850/900 Class E2 (0.4W, 26dBm) per EDGE 1800/1900

Antenna

Tipo	Superficiale per esterni IP69K
------	--------------------------------

Frequenza	AMPS 850MHz GSM 900MHz DCS 1800MHz PCS 1900MHz UMTS 2100MHz
-----------	---

Impedenza	50ohm
-----------	-------

Temperatura di impiego	-40 – +85°C
------------------------	-------------

Guadagno	0dBi
----------	------

Dimensioni	Ø50 x 16mm
------------	------------

Cavo	2.5m
------	------

Connettore	SMA
------------	-----

Montaggio	M10 passante + guarnizione adesiva
-----------	------------------------------------

Contenitore

Versione	DIN rail EN-50022
----------	-------------------

Dimensioni	4 modules (72mm)
------------	------------------

Materiale	Polycarbonate
-----------	---------------

Grado di protezione frontale	IP40 on front – IP20 terminals
------------------------------	--------------------------------

Peso	200g
------	------

Omologazioni e conformità

Conformità a norme	EN 60950-1:2006 FCC rules, parts 15B-22H-27-24E
--------------------	--