

**STExS1F**

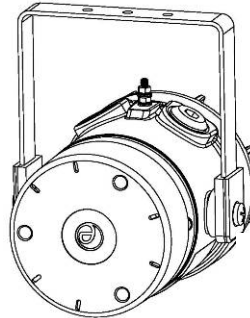

**STExS1R/  
STExS2R**

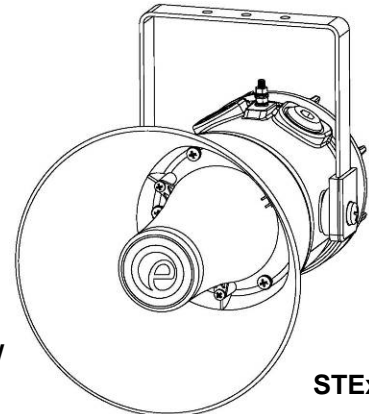

**STExS2F**

### 1) Warnings

- DO NOT OPEN WHEN AN EXPLOSIVE ATMOSPHERE IS PRESENT
- POTENTIAL ELECTROSTATIC CHARGING HAZARD
- ALL ENTRIES M20 X 1.5 - IF TEMPERATURE EXCEEDS 70°C AT ENTRY OR 80°C AT BRANCHING POINT USE SUITABLE RATED CABLE AND CABLE GLANDS



The units can be installed in locations with the following conditions:

#### Area Classification Gas:

Zone 1	Explosive gas air mixture likely to occur in normal operation.
Zone 2	Explosive gas air mixture not likely to occur in normal operation, and if it does, it will only exist for a short time.

#### Gas Groupings:

Group IIA	Propane
Group IIB	Ethylene
Group IIC	Hydrogen and Acetylene

#### Temperature Classification:

T1	450°C
T2	300°C
T3	200°C
T4	135°C
T5	100°C (up to 60°C ambient for STExS2 only)
T6	85°C (up to 65°C ambient for STExS1, up to 45°C ambient for STExS2 only)

#### Area Classification Dust:

Zone 21	Explosive dust air mixture likely to occur in normal operation.
Zone 22	Explosive dust air mixture not likely to occur in normal operation, and if it does, it will only exist for a short time.

#### Dust Groupings:

Group IIIA	Combustible Flyings
Group IIIB	Non-conductive Dust
Group IIIC	Conductive Dust

#### Maximum Surface Temperature for Dust Applications:

85°C (STExS1)  
105°C (STExS2)

**IP Rating:** IP66 to EN/IEC60079-0 and EN/IEC60529

**Equipment Category:** 2G / 2D

**Equipment Protection Level:** Gb, Gc, Db, Dc

**Ambient Temperature Range:** -50°C to +70°C

### 2) Rating & Marking Information

All units have a rating label, which carries the following important information:-

Model No.: STExS1  
STExS2

Input Voltage: DC Units 24V  
AC Units 115V or 230V

#### STExS1 Codes:

Ex db IIC Gb T6 Ta -50°C to +65°C  
Ex db IIC Gb T5 Ta -50°C to +70°C  
Ex tb IIIC Db T85°C Ta -50°C to +70°C

#### STExS2 Codes:

Ex db IIC Gb T6 Ta -50°C to +45°C  
Ex db IIC Gb T5 Ta -50°C to +60°C  
Ex db IIC Gb T4 Ta -50°C to +70°C  
Ex tb IIIC Db T105°C Ta -50°C to +70°C

Certificate No. DEMKO 16 ATEX 1466X  
IECEx ULD 16.0017X

Epsilon x  
Equipment Group and  
Category:

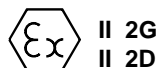

CE Marking  
Notified Body No.



### 3) Type Approval Standards

The sounder carries an EC Type Examination Certificate and IECEx Certificate of Conformity, and have been certified to comply with the following standards:

EN60079-0:2012+A11:2013 / IEC60079-0:2011 (Ed 6): Explosive Atmospheres - Equipment. General requirements

EN60079-1:2014 / IEC60079-1:2014 (Ed 7): Explosive Atmospheres - Equipment protection by flameproof enclosures "d"

EN 60079-31:2014 / IEC 60079-31:2013 (Ed 2): Explosive Atmospheres - Equipment dust ignition protection by enclosure "t"

### 4) Installation Standards

The sounder must only be installed by suitably qualified personnel in accordance with the latest issues of the relevant standards:

EN60079-14 / IEC60079-14: Explosive atmospheres - Electrical installations design, selection and erection

EN60079-10-1 / IEC60079-10-1: Explosive atmospheres - Classification of areas. Explosive gas atmospheres

EN60079-10-2 / IEC60079-10-2: Explosive atmospheres - Classification of areas. Explosive dust atmospheres

The installation of the units must also be in accordance with any local codes that may apply and should only be carried out by a competent electrical engineer who has the necessary training.

### 5) Special Conditions of Use

Repair of the flamepath / flameproof joints is not permitted.

The plastic horn is not anti-static and the metallic enclosure has a non-conductive coating. These may generate an ignition-capable level of electrostatic charges under certain extreme conditions. The user should ensure that the equipment is not installed in a location where it may be subjected to external conditions that might cause a build-up of electrostatic charges on non-conducting surfaces.

Additionally, cleaning of the equipment should be done only with a damp cloth.

### 6) Location and Mounting

The location of the sounder should be made with due regard to the area over which the warning signal must be visible/audible. They should only be fixed to surfaces that can carry the weight of the unit.

The sounder should be secured to any flat surface using the three 7mm fixing holes. The angle can then be adjusted as required but the mounting restrictions must be observe. See Fig 1d. This can be achieved by loosening the two large bracket screws in the side of the unit, which allow adjustments in steps of 18°. The enclosure provides IP66 protection and is suitable for installation in exterior locations providing it is positioned so that water cannot collect in the horn, and the cable entry is sealed. See figure 1.

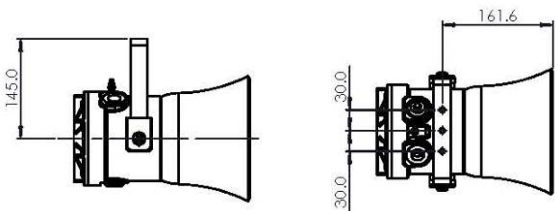

Fig 1a. Fixing Location for Small Horn

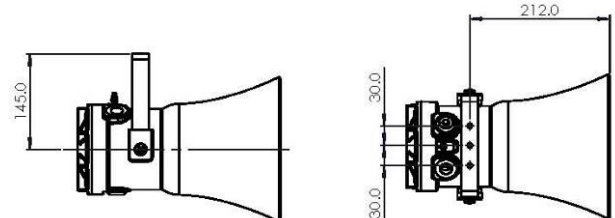

Fig 1b. Fixing Location for Large Horn

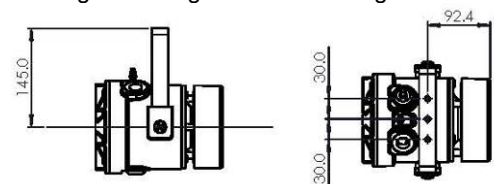

Fig. 1c Fixing Locations for Radial Horn

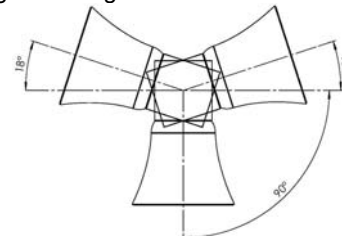

Fig. 1d Mounting Restrictions

### 7) Access to the Flameproof Enclosure



Warning – High voltage may be present, risk of electric shock. DO NOT open when energised, disconnect power before opening.



Warning – Hot surfaces. External surfaces and internal components may be hot after operation, take care when handling the equipment.

In order to connect the electrical supply cables to the sounder it is necessary to remove the flameproof cover to gain access to the flameproof chamber. To access the Ex d chamber, loosen the M4 grub screw on the sounder cover. Open the enclosure by turning the sounder cover counterclockwise and remove the cover, taking extreme care not to damage the flameproof threads in the process (See figure 2).

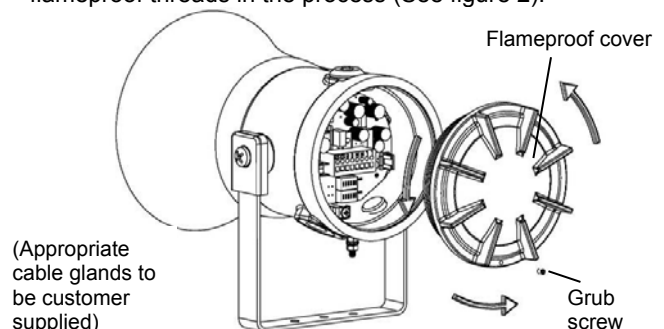

Fig. 2 Accessing the Explosion proof Enclosure.

On completion of the installation, the flameproof threaded joint should be inspected to ensure that they are clean and that they have not been damaged during installation. Repair of the flamepath / flameproof joints is not permitted. Also check that the 'O' ring seal is in place. When fitting the flameproof cover ensure the thread is engaged correctly. Fully tighten the cover all the way, ensure no gap is visible between the cover and base of the sounder enclosure. Tighten the M4 grub screw.

## 8) Power Supply Selection

It is important that a suitable power supply is used to run the equipment. The power supply selected must have the necessary capacity to provide the input current to all of the units.

The following table shows the input current taken by the various sounders and also shows the maximum voltage at which the sounders can be operated.

Model No.	Nominal Voltage	Voltage Range	Nominal Current
STExS1DC024	24Vdc	10-30Vdc	217mA
STExS1AC230	115Vac / 230Vac	110-240Vac 50/60Hz	77mA / 53mA
STExS2DC024	24Vdc	10-30Vdc	924mA
STExS2AC230	115Vac / 230Vac	110-240Vac 50/60Hz	268mA / 159mA

Supply voltage variation of +/-10% outside the voltage range is permissible

Nominal current at nominal voltage

Max rated current at worst case supply voltage and flash rate.

## 9) Selection of Cable, Cable Glands, Blanking Elements & Adapters

When selecting the cable size, consideration must be given to the input current that each unit draws (see table above), the number of sounder on the line and the length of the cable runs. The cable size selected must have the necessary capacity to provide the input current to all of the sounders connected to the line.

For ambient temperatures over +40°C the cable entry temperature may exceed +70°C and therefore suitable heat resisting cables and cable glands must be used as per table below

STExS1:

Ambient Temp.	45°C	50°C	55°C	60°C	65°C	70°C
Min. Rating of cables and cable glands	70°C	75°C	80°C	85°C	90°C	95°C

STExS2:

Ambient Temp.	40°C	45°C	50°C	55°C	60°C	65°C	70°C
Min. Rating of cables and cable glands	75°C	80°C	85°C	90°C	95°C	100°C	105°C

The cable entries have an M20 x 1.5 – 6H entry thread. If the installation is made using cable glands, only suitably rated and ATEX / IECEx certified cable glands must be used. They must be suitable for the type of cable being used and also

meet the requirements of the current installation standards EN 60079-14 / IEC60079-14.

Any unused cable entries must be closed with suitably rated and ATEX / IECEx certified blanking plugs.

If the installation is made using conduit, openings must have a sealing fitting connected as close as practical to the wall of the enclosure, but in no case more than the size of the conduit or 50mm, whichever is the lesser.

If a high IP (Ingress Protection) rating is required then a suitable sealing washer must be fitted under the cable glands or blanking plugs.

For combustible dust applications, the cable entry device and blanking elements shall be in type of explosion protection and shall have an IP 6X rating.

The STEx sounder range can be supplied with the following types of adapters:

M20 to ½" NPT  
M20 to ¾" NPT  
M20 to M25

It is important to note that stopping plugs cannot be fitted onto adapters, only directly onto the M20 entries.

Any other adapters used must be suitably rated and ATEX / IECEx certified adapters.

## 10) Earthing

Both AC and DC sounder units must be connected to an earth according to EN/IEC 60079/14. The units are provided with internal and external earth terminals which are both located on the terminal chamber section of the unit

Internal earthing connections should be made to the Internal Earth terminal in the base of the housing using a ring crimp terminal to secure the earth conductor under the earth clamp. The earth conductor should be at least equal in size and rating to the incoming power conductors.

External earthing connections should be made to the M5 earth stud, using a ring crimp terminal to secure the earth conductor to the earth stud. The external earth conductor should be at least 4mm<sup>2</sup> in size.

## 11) Cable Connections

Electrical connections are to be made into the terminal blocks on the PCBA located in the flameproof enclosure. See section 7 of this manual for access to the flameproof enclosure.

Wires having a cross sectional area between 0.5 mm<sup>2</sup> to 2.5mm<sup>2</sup> can be connected to each terminal way. If an input and output wire is required the 2-off Live/Neutral or +/- terminals can be used. If fitting 2-off wires to one terminal way the sum of the 2-off wires must be a maximum cross sectional area of 2.5mm<sup>2</sup>. Strip wires to 8mm. Wires may also be fitted using ferrules. Terminal screws need to be tightened down with a tightening torque of 0.45 Nm / 5 Lb-in. When connecting wires to the terminals great care should be taken to dress the wires so that when the cover is inserted into the chamber the wires do not exert excess pressure on the terminal blocks. This is particularly important when using cables with large cross sectional areas such as 2.5mm<sup>2</sup>.

## 12) AC Wiring

An 8-way terminal block is provided on the AC Sounder. There are 2-off Live, 2-off Neutral terminals and 1-off Earth terminals in total. The sounder PCBA is pre-wired into the sounder, if separate wiring is required see section 14.

### 12.1 Wiring Diagrams

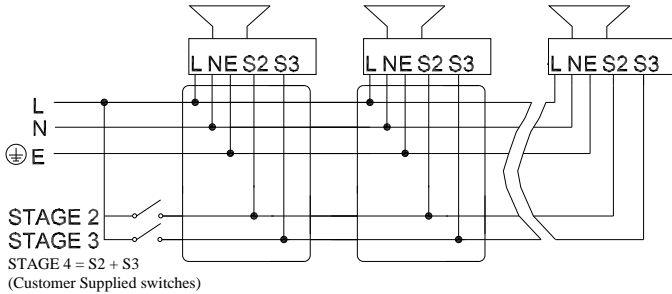

Fig 3a. STExS1AC Simplified Block Diagram

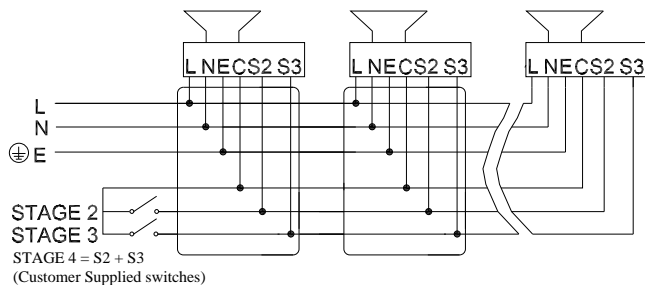
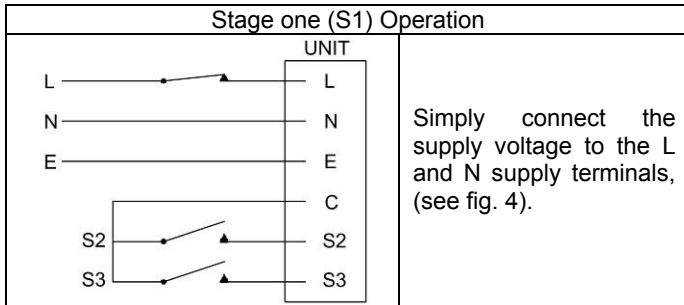

Fig 3b. STExS2AC Simplified Block Diagram

### 12.2 Stage Switching

#### 12.2.1 Units First Stage Tones



#### 12.2.2 AC Units Second, Third and Fourth Stage Tone Selection

To select the second, third and fourth stage tones on the STExS1 AC sounder.

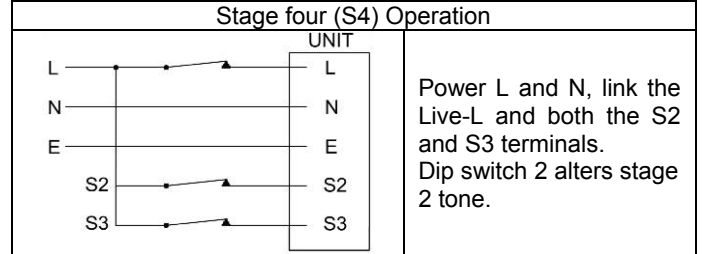
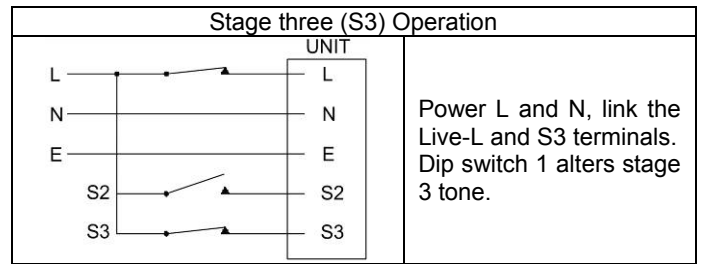
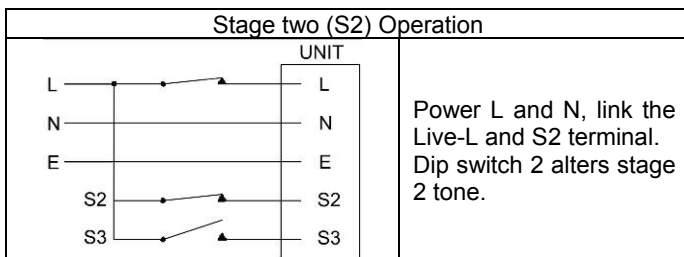

To select the second, third and fourth stage tones on the STExS2 AC sounder.

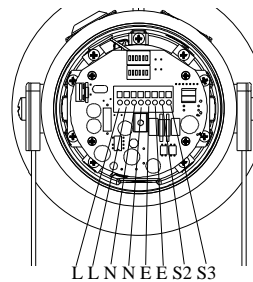
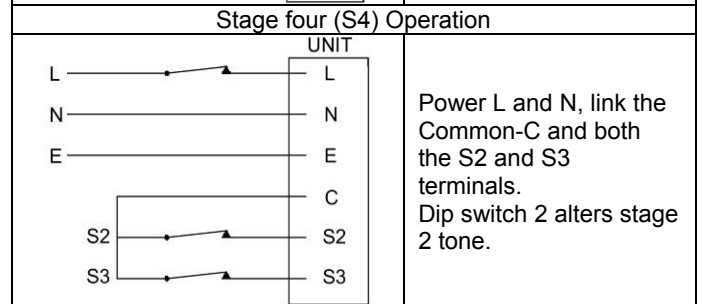
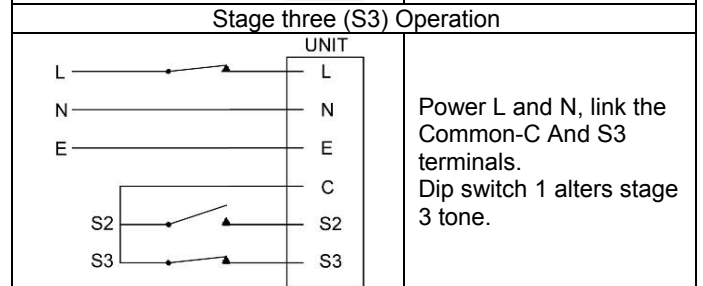
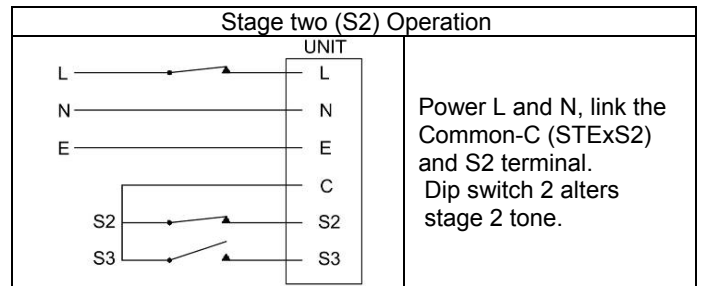

STExS1AC Terminals

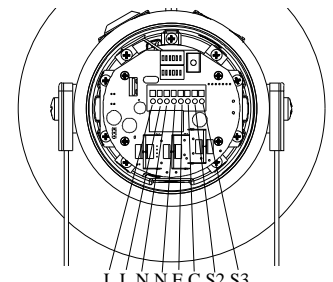

STExS2AC Terminals

Fig. 4 AC Terminals

## 13) DC Wiring

A 6-way terminal block is provided on the DC Sounder. There are 2-off +ve, 2-off -ve, 1-off stage 2 and 1-off stage 3 terminals in total.

### 13.1 Wiring Diagrams

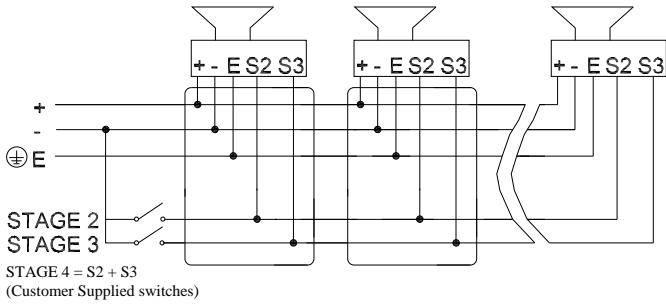

Fig. 5a DC Simplified Block Diagram (negative switching)

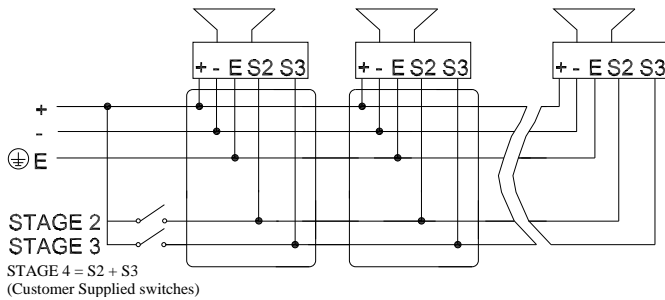
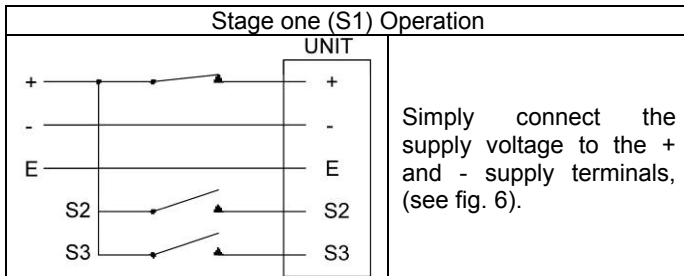

Fig. 5b DC Simplified Block Diagram (positive switching)

### 13.2 Stage Switching

#### 13.2.1 Units First Stage Tones



#### 13.2.2 DC Units Second, Third and Fourth Stage Tone Selection

For units set up for -ve switching (default setting):

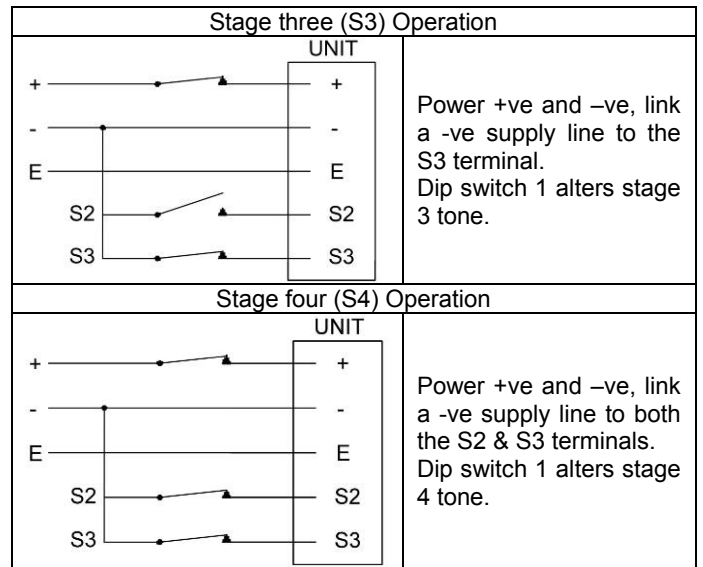
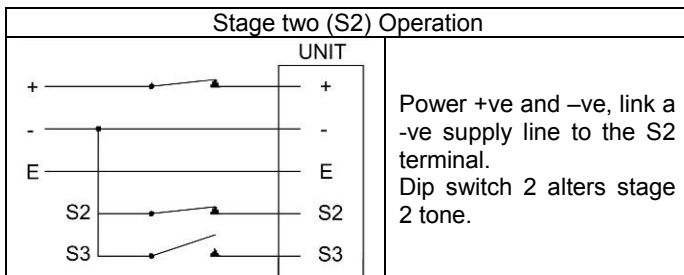

For units set up for +ve switching (refer to 13.3):

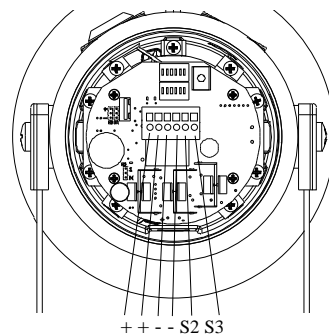
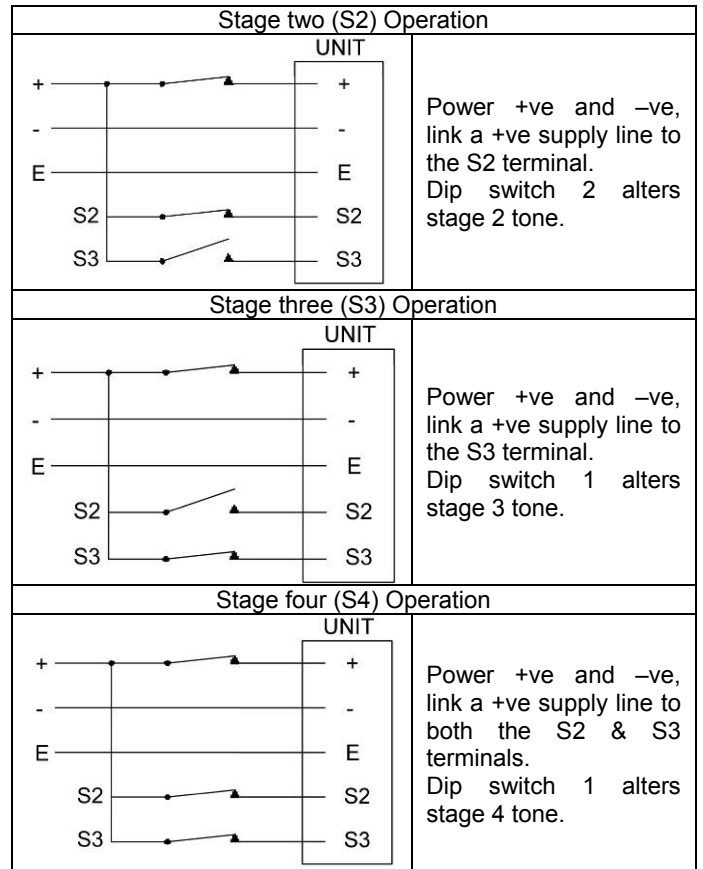

Fig. 6 DC Terminals

### 13.3 Stage Switching Polarity (DC Units Only)

The STExS2 and STExS1 DC sounders have the facility to use either +ve or -ve switching to change the tone to the second, third and fourth stages. Negative switching is the default setting. For -ve switching connect the two headers on the pcb to the left-hand (marked -ve) and centre pins. For +ve switching connect the headers to the right hand (marked +ve) and the centre pins. (Refer to Fig. 7)

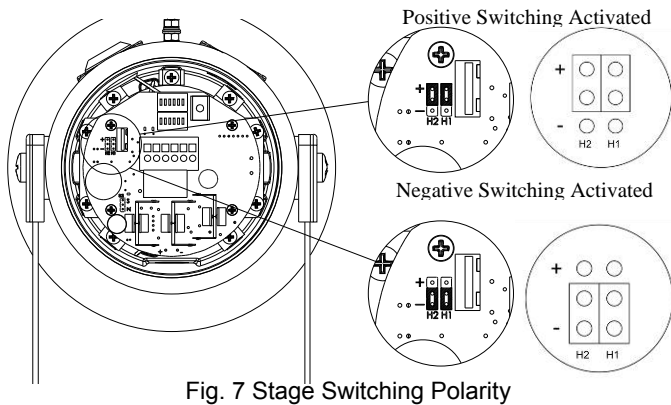

Fig. 7 Stage Switching Polarity

### 13.4 End of Line Monitoring (DC Units Only)

On STExS1DC & STExS2DC units, dc reverse line monitoring can be used if required. All DC sounders have a blocking diode fitted in their supply input lines. An end of line monitoring diode or an end of line monitoring resistor can be connected across the +ve and -ve terminals. If an end of line resistor is used it must have a minimum resistance value of 3k3Ω and a minimum power rating of 0.5 watts or a minimum resistance value of 500Ω and a minimum power rating of 2 watts.

The resistor must be connected directly across the +ve and -ve terminals as shown in the following drawing. The resistor leads should be kept as short as possible.

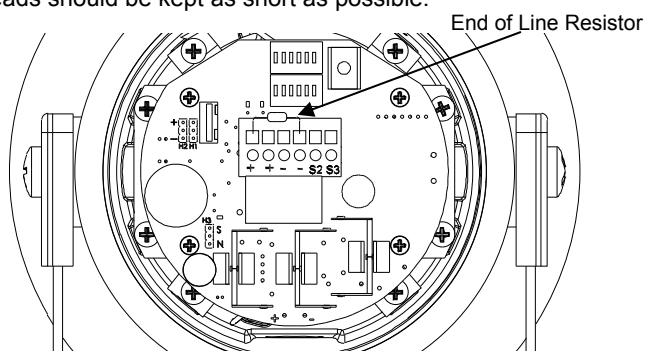

Fig. 8 End of Line Resistor Placement

## 14) Settings

### 14.1 Tone Selection

The STExS1 & STExS2 units have 64 different tones that can be selected independently for the first and second stage alarms. The tones are selected by operation of the tone setting DIP switches 1 & 2 (see Fig. 9) on the PCB. The sounder can also be switched to sound the third and fourth stage alarm tones. The tone table (Table 1) shows the switch positions for the 64 tones on first and second stages and which tones are available for the third and fourth stages dependent on the Stage 1 DIP switch setting.

### 14.2 Volume Control



Warning - High noise levels above 85dB(A) during operation. High levels of noise may cause hearing loss, wear suitable ear protection when equipment is in operation.

The output level of the STEx sounder can be set by adjusting the volume control potentiometer (see Fig 9). For maximum output, set the potentiometer fully clockwise.

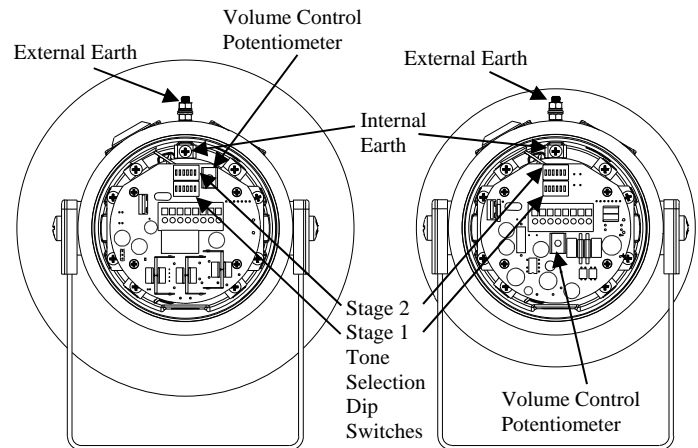

STExS2AC / STExS2DC / STExS1DC / STExS1AC

Fig. 9 Location of field controls

## 15) Maintenance, Overhaul and Repair

Maintenance, repair and overhaul of the equipment should only be carried out by suitably qualified personnel in accordance with the current relevant standards:

EN60079-19/IEC60079-19

Explosive atmospheres – Equipment repair, overhaul and reclamation

EN 60079-17/IEC60079-17

Explosive atmospheres – Electrical installations inspection and maintenance

Units must not be opened while an explosive atmosphere is present.



If opening the unit during maintenance operations a clean environment must be maintained and any dust layer removed prior to opening the unit.

Flameproof threaded joints and cemented joints are not permitted to be repaired.

Electrostatic charging hazard - Clean only with a damp cloth.

**Tone Selection** – To select the required first stage tone set the tone Set DIP switch 1 (6 way DIP see Fig 3) to the required tone setting shown in the table below. The table also shows the second stage tone can be set independently with the Stage 2 DIP switch to select the required tone. The 3<sup>rd</sup> and 4<sup>th</sup> stage tones are available if more than two tone output stages are required, they are set/linked via the first stage tone selection.

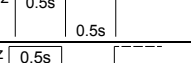
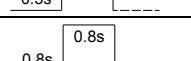
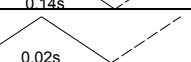
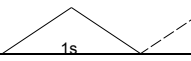
Stage 1 Set DIP Switch 1 Tone No	Tone Description	Tone Visual	Stage 1 & 2 DIP Switch Settings 1 2 3 4 5 6	Stage 2 Set DIP Switch 2 Tone (S2)	Stage 3 Set DIP Switch 1 Tone (S3)	Stage 4 Set DIP Switch 1 Tone (S2 + S3)
1	1000Hz PFEER Toxic Gas	1000Hz _____	0 0 0 0 0 0	1	2	44
2	1200/500Hz @ 1Hz DIN / PFEER P.T.A.P.		1 0 0 0 0 0	2	3	44
3	1000Hz @ 0.5Hz(1s on, 1s off) PFEER Gen. Alarm		0 1 0 0 0 0	3	2	44
4	1.4KHz-1.6KHz 1s, 1.6KHz-1.4KHz 0.5s NF C 48-265		1 1 0 0 0 0	4	24	1
5	544Hz(100mS)/440Hz (400mS) NF S 32-001		0 0 1 0 0 0	5	19	1
6	1500/500Hz - (0.5s on , 0.5s off) x3 + 1s gap AS4428		1 0 1 0 0 0	6	44	1
7	500-1500Hz Sweeping 2 sec on 1 sec off AS4428		0 1 1 0 0 0	7	44	1
8	500/1200Hz @ 0.26Hz(3.3s on, 0.5s off) Netherlands - NEN 2575		1 1 1 0 0 0	8	24	35
9	1000Hz (1s on, 1s off)x7 + (7s on, 1s off) IMO Code 1a		0 0 0 1 0 0	9	34	1
10	1000Hz (1s on, 1s off)x7 + (7s on, 1s off) IMO Code 1a		1 0 0 1 0 0	10	34	1
11	420Hz(0.5s on, 0.5s off)x3 + 1s gap ISO 8201 Temporal Pattern		0 1 0 1 0 0	11	1	8
12	1000Hz(0.5s on, 0.5s off)x3 + 1s gap ISO 8201 Temporal Pattern		1 1 0 1 0 0	12	1	8
13	422/775Hz - (0.85 on, 0.5 off) x3 + 1s gap NFPA - Temporal Coded		0 0 1 1 0 0	13	1	8
14	1000/2000Hz @ 1Hz Singapore		1 0 1 1 0 0	14	3	35
15	300Hz Continuous	300Hz _____	0 1 1 1 0 0	15	24	35
16	440Hz Continuous	440Hz _____	1 1 1 1 0 0	16	24	35
17	470Hz Continuous	470Hz _____	0 0 0 0 1 0	17	24	35
18	500Hz Continuous IMO code 2 (Low)	500Hz _____	1 0 0 0 1 0	18	24	35
19	554Hz Continuous	554Hz _____	0 1 0 0 1 0	19	24	35
20	660Hz Continuous	660Hz _____	1 1 0 0 1 0	20	24	35
21	800Hz IMO code 2 (High)	800Hz _____	0 0 1 0 1 0	21	24	35
22	1200Hz Continuous	1200Hz _____	1 0 1 0 1 0	22	24	35
23	2000Hz Continuous	2000Hz _____	0 1 1 0 1 0	23	3	35
24	2400Hz Continuous	2400Hz _____	1 1 1 0 1 0	24	20	35
25	440 @0.83Hz (50 cycles/minute) Intermittent		0 0 0 1 1 0	25	44	8
26	470 @0.9Hz - 1.1s Intermittent		1 0 0 1 1 0	26	44	8
27	470Hz @5Hz - (5 cycles/second) Intermittent		0 1 0 1 1 0	27	44	8
28	544Hz @ 1.14Hz - 0.875s Intermittent		1 1 0 1 1 0	28	24	8
29	655Hz @ 0.875Hz Intermittent		0 0 1 1 1 0	29	44	8
30	660Hz @0.28Hz - 1.8sec on, 1.8sec off Intermittent		1 0 1 1 1 0	30	24	8
31	660Hz @3.34Hz - 150mS on, 150mS off Intermittent		0 1 1 1 1 0	31	24	8

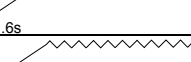
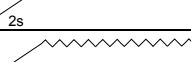
32	745Hz @ 1Hz Intermittent		1 1 1 1 1 0	32	24	8
33	800Hz - 0.25sec on, 1 sec off Intermittent		0 0 0 0 0 1	33	24	8
34	800Hz @ 2Hz IMO code 3.a (High) Intermittent		1 0 0 0 0 1	34	24	8
35	1000Hz @ 1Hz Intermittent		0 1 0 0 0 1	35	24	8
36	2400Hz @ 1Hz Intermittent		1 1 0 0 0 1	36	24	8
37	2900Hz @ 5Hz Intermittent		0 0 1 0 0 1	37	24	8
38	363/518Hz @ 1Hz Alternating		1 0 1 0 0 1	38	8	19
39	450/500Hz @ 2Hz Alternating		0 1 1 0 0 1	39	8	19
40	554/440Hz @ 1Hz Alternating		1 1 1 0 0 1	40	24	19
41	554/440Hz @ 0.625Hz Alternating		0 0 0 1 0 1	41	8	19
42	561/760Hz @ 0.83Hz (50 cycles/minute) Alternating		1 0 0 1 0 1	42	8	19
43	780/600Hz @ 0.96Hz Alternating		0 1 0 1 0 1	43	8	19
44	800/1000Hz @ 2Hz Alternating		1 1 0 1 0 1	44	24	19
45	970/800Hz @ 2Hz Alternating		0 0 1 1 0 1	45	8	19
46	800/1000Hz @ 0.875Hz Alternating		1 0 1 1 0 1	46	24	19
47	2400/2900Hz @ 2Hz Alternating		0 1 1 1 0 1	47	24	19
48	500/1200Hz @ 0.3Hz Sweeping		1 1 1 1 0 1	48	24	12
49	560/1055Hz @ 0.18Hz Sweeping		0 0 0 0 1 1	49	24	12
50	560/1055Hz @ 3.3Hz Sweeping		1 0 0 0 1 1	50	24	12
51	600/1250Hz @ 0.125Hz Sweeping		0 1 0 0 1 1	51	24	12
52	660/1200Hz @ 1Hz Sweeping		1 1 0 0 1 1	52	24	12
53	800/1000Hz @ 1Hz Sweeping		0 0 1 0 1 1	53	24	12
54	800/1000Hz @ 7Hz Sweeping		1 0 1 0 1 1	54	24	12
55	800/1000Hz @ 50Hz Sweeping		0 1 1 0 1 1	55	24	12
56	2400/2900Hz @ 7Hz Sweeping		1 1 1 0 1 1	56	24	12
57	2400/2900Hz @ 1Hz Sweeping		0 0 0 1 1 1	57	24	12
58	2400/2900Hz @ 50Hz Sweeping		1 0 0 1 1 1	58	24	12
59	2500/3000Hz @ 2Hz Sweeping		0 1 0 1 1 1	59	24	12
60	2500/3000Hz @ 7.7Hz Sweeping		1 1 0 1 1 1	60	24	12
61	800Hz Motor Siren		0 0 1 1 1 1	61	24	12
62	1200Hz Motor Siren		1 0 1 1 1 1	62	24	12
63	2400Hz Motor Siren		0 1 1 1 1 1	63	24	12
64	Simulated Bell		1 1 1 1 1 1	64	21	12